



AVK SURFACE BOX H-4059VF HD-GG

80/33
300

Height adjustable with Fugenring
Surface box for service connection valves
Standard lid inscription: GAS

Type

- H-4059VF HD-GG
- Square cast iron lid
- Square top surface box

Features

- Lightweight, user-friendly, silent and maintenance free
- 100% recyclable and significantly less use of resources compared to traditional materials
- Manufactured out of high grade recycled materials
- Ribs in housing ensure optimal fixation in road foundation
- Selected materials for housing and lid ensure easy opening at all times
- Heat resistant to max. 250 °C
- Suitable for low-temperature applications
- Large height range and flexible positioning of top part
- Inscription in lid to be positioned easily
- No height adjustment needed after installation, saving time and costs
- Floating top part following road settlement ensuring perfect alignment at all times
- Reinforced rim ensures better support of top part
- Durable joint between tarmac and surface box
- Installation according to ZTV Fug-StB 15 guidelines
- D400 load bearing capacity

Optional

- Various colours and lid inscriptions possible
- Spring around bolt ensuring lid will stay in its place

Standards

- Design according to DIN 4059
- DVGW VP 310-2
- DVGW approval, certificate DG-4531CN0476

Accessories

- Support tile I



Expect... **AVR**

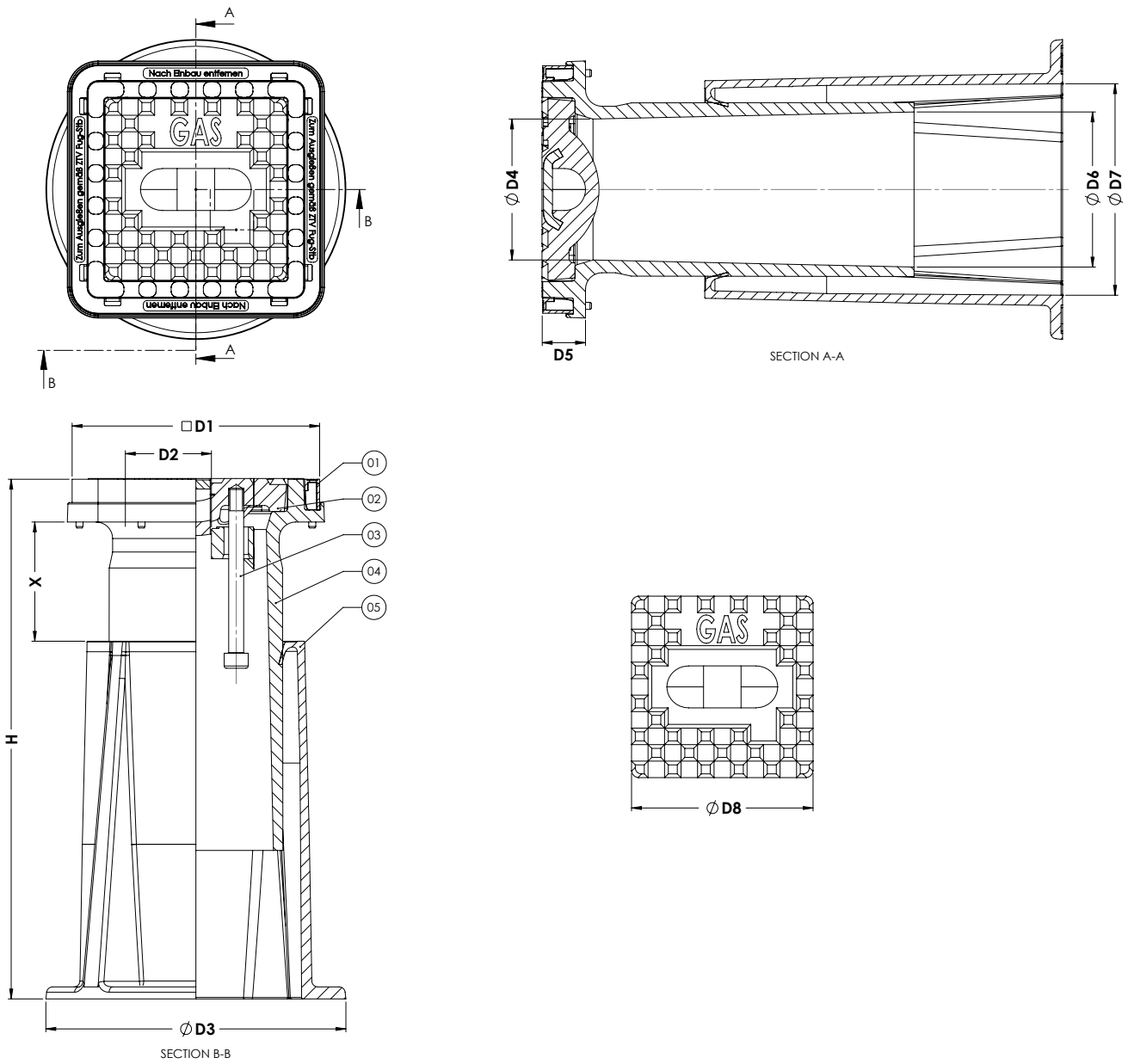

Component list

1. Fugenring	PA
2. Lid	EN-GJL-200
3. Bolt M12x130 hexagon socket head	A2-70
4. Housing top part	PA+
5. Housing bottom part	PA+

Reference nos. and nominal dimensions

AVK ref. nos.	D1 mm	D2 mm	D3 mm	D4 mm	D5 mm	D5 mm	D6 mm	D7 mm	H mm	X mm
80-33-3900000	165	68	200	94	29	103	141	120	347-447	80-180
	Weight box in kg	Weight lid in kg	Total weight in kg							
	1.8	1.9	3.7							

For other variants different item numbers apply
 Dimensions are subject to tolerances